

INDIA'S FIRST pH/ORP CONTROL DOSING PUMP

@dose Neutra | **@dose** Chloro
Electronic Metering Pump | Electronic Metering Pump

Dosing Pumps

SPECIFICATION

pH/ORP SENSOR

pH Range	:2-11 pH
ORP Range	:-1000 to +1000 mV
Body Material	:Glass
Max. Operating pressure	:5 kg/cm ²
Cable Length	:5 mtrs
Mounting Thread	:3/4" BSPM

DOSING PUMP

ELECTRICAL:	:230 V AC [+/- 20%] 50HZ
SUCTION TUBING	:4/6 mm
DISCHARGE TUBING	:4/6 mm
DOSING RATE	:1.5/3/6/10 LPH at 4 Kg/cm ²
Wetted Parts	:PP/PVDF



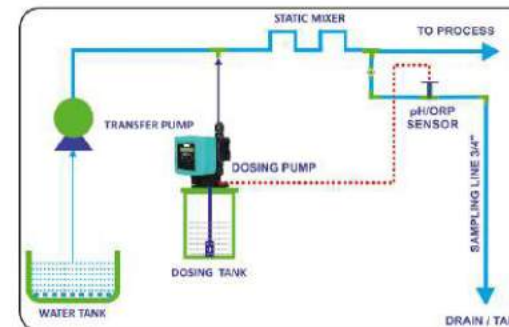

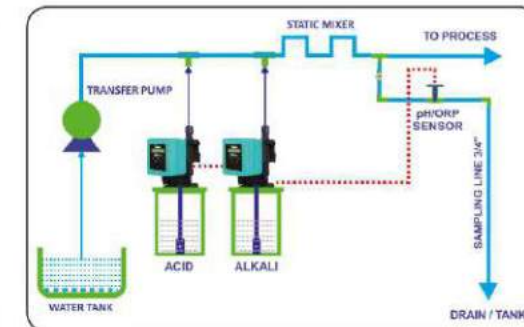

SCHEMATIC



DUAL SIDE pH CORRECTION



FEATURES

-  Inbuilt Transmitter
-  Loaded with Fuzzy logic
-  16x2 Dual light LCD Display
-  Non-tactile keypad
-  Suitable for Acid/Alkali Dosing
-  Suitable for Chlorination/Dechlorination Dosing

Also available in PVDF for Sulphuric Acid Application

FILTRA CONSULTANTS AND ENGINEERS LTD.

Gala No. 2 & 3, Ground Floor, Neminath Industrial Estate No. 2, Navghar, Vasai (East), Dist.: Palghar - 401 219
Tel.: +91 8691009127/26 Email: filtraw@gmail.com Website: www.ewater-treatmentindia.com

